

# Paraflex

*Unique Wall Mounted Umbrella*

**Create the shade where you want, independent of the sun's position**

- The only umbrella designed specifically for wall-mounting
- Easy to open and close
- Removable in seconds with easy "lift-lock" bracket
- Ultra light aluminium frame
- Post mounting options also available
- Install 1, 2 or 5 canopies on one central post



50 km/h  
Wind Rating



The unique Paraflex wall mount system removes the need for a heavy base and central pole, and is perfect for 'tight' areas. The flexible arms and tilting canopy allow you to create the shade where you want, independent of the sun's position. Paraflex has a modern design and is very easy to use.

Umbrella Open



Umbrella Closed (with protective cover)

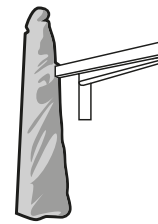

Evolution Arm Length

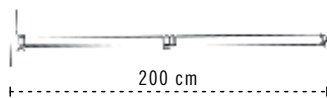

### Dimensions



1.9m Sq

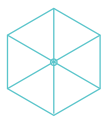

2.7m Hex

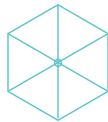

3m Hex

### Standard Colours



Black



Smoked Tweed



Slate



Natural

Canopies are made of water repellent and UV-resistant 100% Solution Dyed Olefin Canvas (2 year warranty against fading).

Premium 100% Solution Dyed Acrylic Canvas (10 year warranty against fading) also available, surcharge applies.

\*Fabric colours may vary slightly from printed swatches shown above.

### Pole Mounting Options

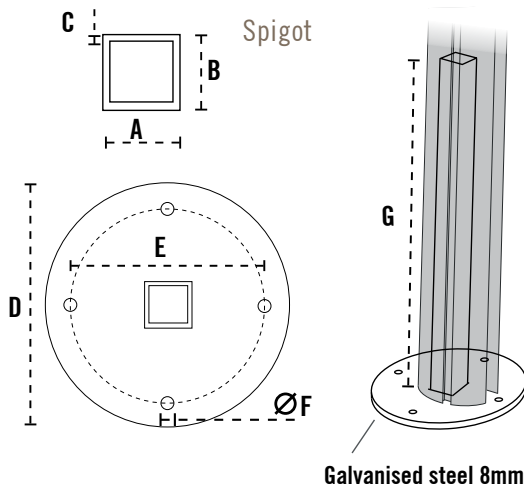

Monoflex

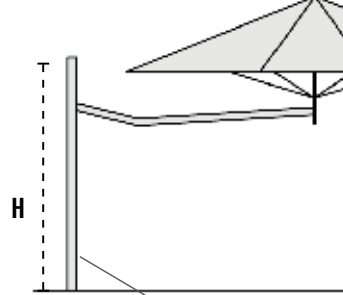

Multipole

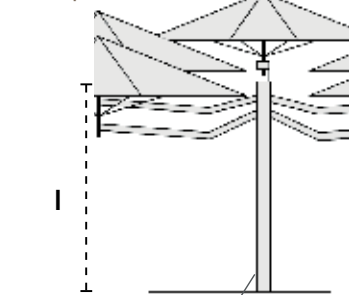

Extruded Aluminium Alloy 6060, naturally anodised

### Spigot Dimensions

A	B	C	D	E	F	G	H	I
40mm	40mm	3mm	215mm	170mm	11mm	490mm	205mm or 215mm	230mm

### Wind Guidance\*

	1.9M	2.7M	3M
Wall installation rating (km/h)	50	40	30
Pole Mounted wind rating (km/h)	50	40	30

\*The above wind speeds are provided as a guide only. Refer to our website and Product Owner Manual provided with the umbrella for more information. The product warranty does not cover wind damage regardless of wind speed.

